

Plafoniera LED IP65 120cm 60W 6000lm 6000K

Codice **929820**

Modello **IP65-PL60WF**

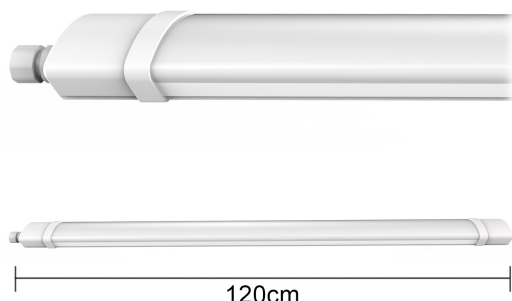

Caratteristiche generali

- Luce istantanea.
- Bassa temperatura.
- Dimensioni: 1200x80x45mm.
- Peso: 520g.

Caratteristiche illuminotecniche

- Flusso luminoso (Φ_{360°): 6000lm.
- Temperatura di colore: 6000K.
- Angolo del fascio: 120°.
- CRI: 80.
- Durata: 25000 ore.
- Cicli di accensione: 12500.

Caratteristiche elettriche

- Tensione: 175-250V AC 50Hz.
- Potenza: 60W.
- Fattore di sfasamento: 0.9.
- Consumo: 60kWh/1000h.



8059174950842